







Series 4411

-  blind holes
-  steam oxide
-  external cooling

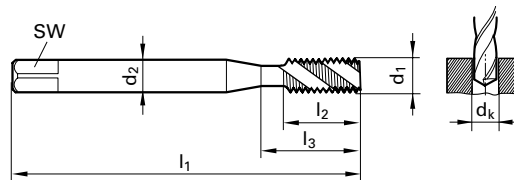



Standard ASME B94.9-1999
Standard ANSI
Tool Material HSS-E (Cobalt)
Flute RH 40° Spiral
Chamfer Form C (2-3)

Tolerance ISO 2 / 6H
Cutting Direction right-hand

d1 - P	Thread Limits	d2	SW	dk	l1	l2	l3	Order Code	EDP Number
mm		inch	inch	mm	inch	inch	inch		
M3 x 0.50	D3	0.141	0.110	2.500	1.941	0.236	0.709	3.000	9044110030000
M3.5 x 0.60	D4	0.141	0.110	2.900	2.000	0.275	0.748	3.500	9044110035000
M4 x 0.70	D4	0.168	0.131	3.300	2.130	0.295	0.827	4.000	9044110040000
M5 x 0.80	D4	0.194	0.152	4.200	2.382	0.334	0.945	5.000	9044110050000
M6 x 1.00	D5	0.255	0.191	5.000	2.500	0.433	1.181	6.000	9044110060000
M7 x 1.00	D5	0.318	0.238	6.000	2.720	0.433	1.377	7.000	9044110070000
M8 x 1.25	D5	0.318	0.238	6.800	2.720	0.551	1.377	8.000	9044110080000
M10 x 1.50	D6	0.381	0.286	8.500	2.941	0.629	1.456	10.000	9044110100000
M12 x 1.75	D6	0.367	0.275	10.300	3.381	0.728	N/A	12.000	9044110120000
M14 x 2.00	D7	0.429	0.322	12.000	3.591	0.787	N/A	14.000	9044110140000
M16 x 2.00	D7	0.480	0.360	14.000	3.811	0.787	N/A	16.000	9044110160000
M18 x 2.50	D7	0.542	0.406	15.500	4.031	0.984	N/A	18.000	9044110180000
M20 x 2.50	D8	0.652	0.489	17.500	4.469	0.984	N/A	20.000	9044110200000
M24 x 3.00	D8	0.760	0.570	21.000	4.909	1.181	N/A	24.000	9044110240000



Series 4412



-  blind holes
-  TiCN coated
-  external cooling

d1 - P	Thread Limits	d2	SW	dk	l1	l2	l3	Order Code	EDP Number
mm		inch	inch	mm	inch	inch	inch		
M3 x 0.50	D3	0.141	0.110	2.500	1.941	0.236	0.709	3.000	9044120030000
M3.5 x 0.60	D4	0.141	0.110	2.900	2.000	0.275	0.748	3.500	9044120035000
M4 x 0.70	D4	0.168	0.131	3.300	2.130	0.295	0.827	4.000	9044120040000
M5 x 0.80	D4	0.194	0.152	4.200	2.382	0.334	0.945	5.000	9044120050000
M6 x 1.00	D5	0.255	0.191	5.000	2.500	0.433	1.181	6.000	9044120060000
M7 x 1.00	D5	0.318	0.238	6.000	2.720	0.433	1.377	7.000	9044120070000
M8 x 1.25	D5	0.318	0.238	6.800	2.720	0.551	1.377	8.000	9044120080000
M10 x 1.50	D6	0.381	0.286	8.500	2.941	0.629	1.456	10.000	9044120100000
M12 x 1.75	D6	0.367	0.275	10.300	3.381	0.728	N/A	12.000	9044120120000
M14 x 2.00	D7	0.429	0.322	12.000	3.591	0.787	N/A	14.000	9044120140000
M16 x 2.00	D7	0.480	0.360	14.000	3.811	0.787	N/A	16.000	9044120160000
M18 x 2.50	D7	0.542	0.406	15.500	4.031	0.984	N/A	18.000	9044120180000
M20 x 2.50	D8	0.652	0.489	17.500	4.469	0.984	N/A	20.000	9044120200000
M24 x 3.00	D8	0.760	0.570	21.000	4.909	1.181	N/A	24.000	9044120240000