

**GENERAL INSTRUCTIONS**

- 1) ALLOW AMPLIE WORKING SPACE FOR ASSEMBLY. USE THE EMPTY CARTONS AS THE WORK SURFACE. STORE LIKE PARTS TOGETHER AS CLOSE AS POSSIBLE TO WORK AREA.
- 2) ESSENTIAL TOOLS FOR ASSEMBLING LOCKERS ARE: 11/32" SOCKET WRENCH, PLIERS, AND TWO DRIFT PINS FOR ALIGNING HOLES.
- 3) NUTS ARE ALWAYS ON THE INSIDE OF LOCKERS; ALL NUTS SHOULD BE "FINGER TIGHT" UNTIL THE COMPLETE GROUP IS ASSEMBLED.
- 4) IN THE INTEREST OF SAFETY, LYON RECOMMENDS THAT LOCKERS BE FLOOR AND/OR WALL ANCHORED.

**OPERATION No. 4**

- 1) BOLT DOORS AND FRAMES THROUGH ALL HOLES. WHEN ALL BOLTS ARE INSTALLED, TIGHTEN ALL NUTS.
- 2) INSERT LOCKER LEGS THROUGH OPENINGS IN THE BOTTOM. BOLT IN PLACE.
- 3) CAREFULLY STAND LOCKERS UPRIGHT, AND ATTACH BOX LOCKER PULLS. (SEE DETAIL) CARRY THEM TO THEIR LOCATION AND ADJUST REAR LEGS FOR PROPER LEVEL. —CAUTION— LOCKERS MUST BE ANCHORED BEFORE THEY ARE USED. SEE BACK OF PAGE FOR ANCHORING INSTRUCTIONS.

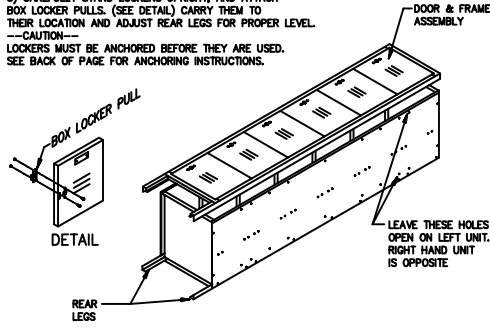

**OPERATION No. 4**

- 1) ATTACH THE DOOR & FRAME ASSEMBLY TO THE BODY ASSEMBLY AS SHOWN
- 2) ATTACH THE BOX LOCKER PULLS TO EACH DOOR.

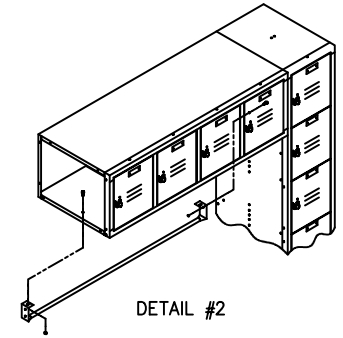
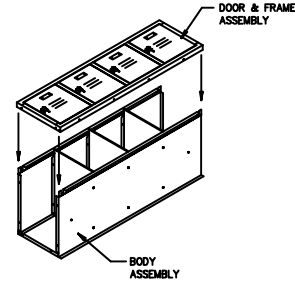

**6 TIER SECTIONS (2)**

**OPERATION No. 1**

- 1) BOLT A TOP AND BOTTOM TO A BACK. THE TOP AND BOTTOM MUST SIT INSIDE OF THE BACK FLANGES.

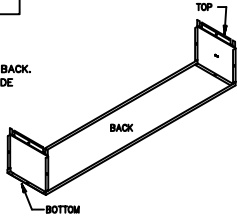

**HORIZONTAL SECTION**

**OPERATION No. 1**

- 1) BOLT THE INTERMEDIATE SIDES TO THE BACK AS SHOWN

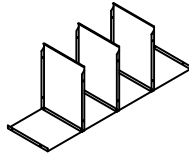

**OPERATION No. 2**

- 1) BOLT A SIDE TO THE BACK, TOP AND BOTTOM. OMIT THE TWO REAR LEG BOLTS.
- 2) BOLT AN INTERMEDIATE SHELF TO THE SIDE. (AND BACK WHEN REQUIRED)

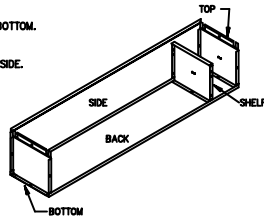

**NOTE:**  
ON MULTIPLE TIER LOCKERS, INTERMEDIATE BOTTOMS DIVIDE THE INTERIOR. SHELVES ARE NOT USED.

**OPERATION No. 2**

- 1) BOLT A TOP TO THE BACK. FASTEN THE TOP TO THE INTERMEDIATE SIDES AS WELL. NOTE THAT THE FLANGES ON THE BACK MUST BE ON THE OUTSIDE OF THE FLANGES ON THE TOP AND BOTTOM

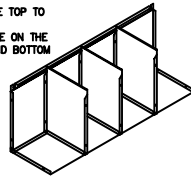

**OPERATION No. 3**

- 1) CONTINUE TO ATTACH INTERMEDIATE SHELVES TO THE SIDES AND BACK AS SHOWN BELOW
- 2) ATTACH THE OPPOSITE SIDE TO THE BACK, AND TO ALL INTERMEDIATE SHELVES.

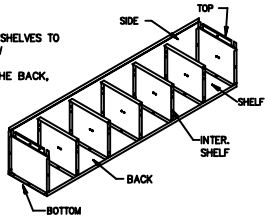

**OPERATION No. 3**

- 1) BOLT A TOP TO THE BACK. FASTEN THE TOP TO THE INTERMEDIATE SIDES AS WELL. NOTE THAT THE FLANGES ON THE BACK MUST BE ON THE OUTSIDE OF THE FLANGES ON THE TOP AND BOTTOM

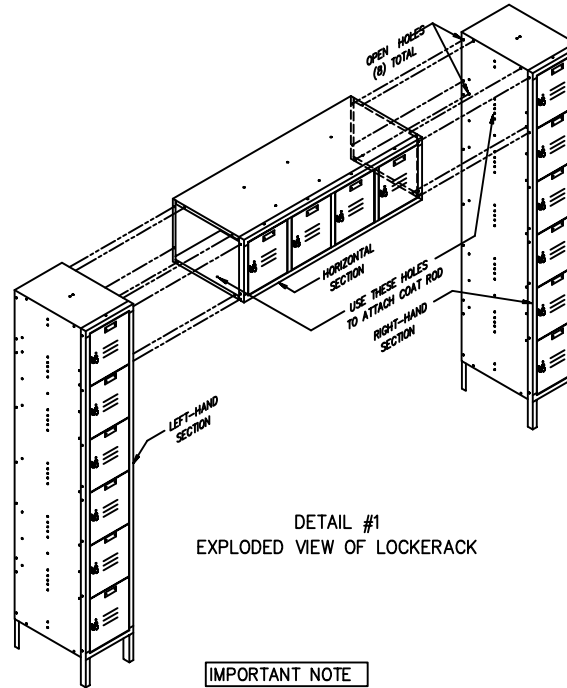
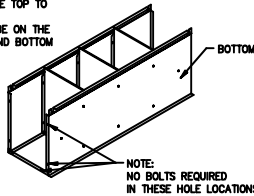

**ASSEMBLY INSTRUCTIONS**

- 1.) LAY BOTH THE RIGHT & LEFT HAND UNITS ON THEIR BACKS SO THAT THE DOORS ARE FACING UPWARD. ATTACH THE CENTER SECTION WITH THE HARDWARE PROVIDED. (DETAIL #1)
- 2.) NEXT ATTACH THE COAT ROD TO THE HORIZONTAL SECTION USING THE OPEN HOLES ON THE BOTTOM (DETAIL #2)
- 3.) THEN ATTACH THE HOLES IN THE COAT ROD TO THE SIDES OF THE LEFT & RIGHT HAND SECTIONS. (DETAIL #2)

**IMPORTANT NOTE**

DUE TO THE WIDE VARIETY OF BUILDING MATERIALS AND CONDITIONS "LYON" DOES NOT FURNISH ANCHORING MATERIALS. THE RECOMMENDED ANCHORS LISTED BELOW CAN BE PURCHASED AT A LOCAL HARDWARE STORE. ANCHORS MUST BE INSTALLED PER THE MANUFACTURERS INSTRUCTIONS.

ASSEMBLY INSTRUCTIONS FOR  
K.D. 16 PERSON LOCKERACK  
AND HORIZONTAL SECTION

LYON METAL PRODUCTS, INC.  
P.O. BOX 671 AURORA, IL 60507

REVISIONS  
9217-AA

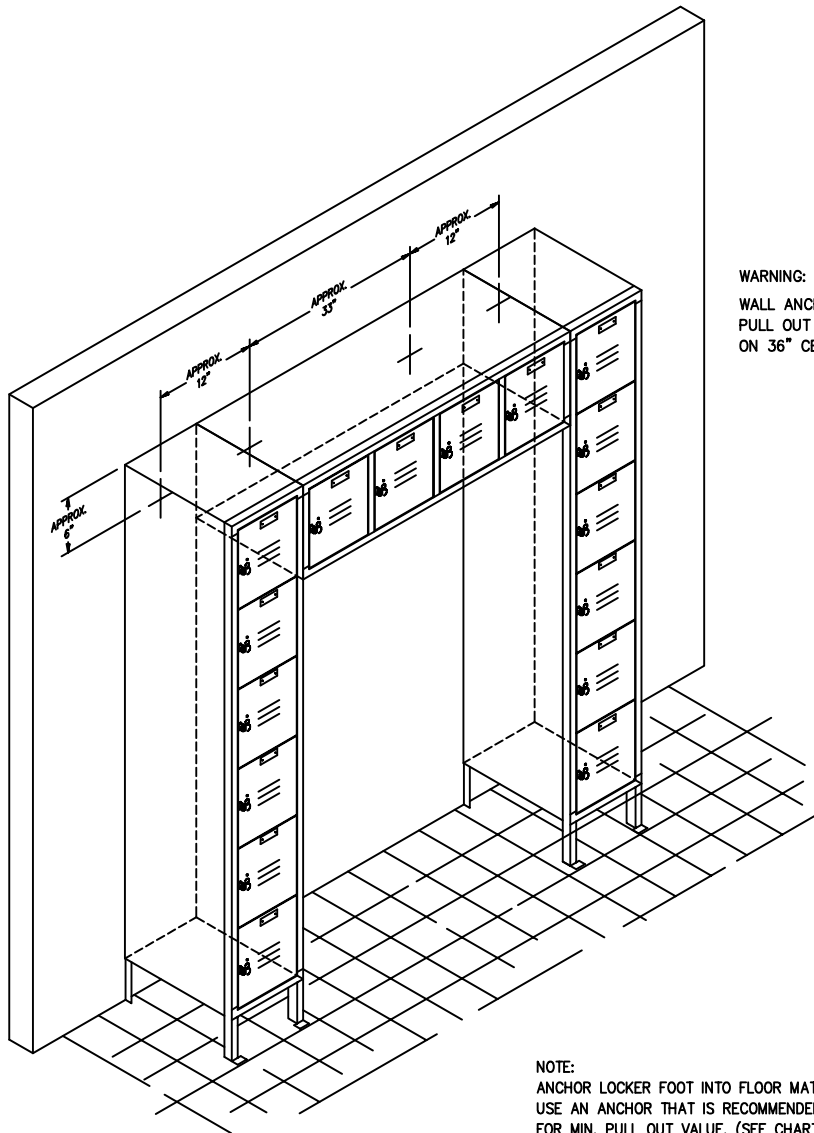

**WARNING:**  
WALL ANCHOR MUST HAVE A MINIMUM PULL OUT VALUE OF 150 LBS. SPACED ON 36" CENTERS MAX.

**NOTE:**  
ANCHOR LOCKER FOOT INTO FLOOR MATERIAL. USE AN ANCHOR THAT IS RECOMMENDED BY LYON FOR MIN. PULL OUT VALUE. (SEE CHART)  
ANCHOR MUST HAVE A MINIMUM PULL-OUT VALUE OF 190 LBS.

**LOCKERACK ACCESSORIES**

**FRONT & END BASES**

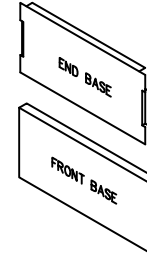
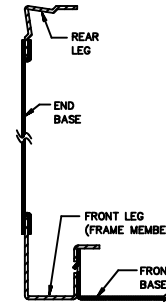

**NOTE:**  
IF THE SPACE BETWEEN THE BOTTOM OF THE LOCKERS AND THE FLOOR IS TO BE CLOSED, FRONT AND END BASES MUST BE ORDERED.

- 1.) END BASES MUST BE ATTACHED BEFORE THE LOCKER FOOT IS ATTACHED. END BASES SLIDE UP OVER THE FRONT AND REAR LEGS OF THE END LOCKERS
- 2.) A FRONT BASE IS INSTALLED BY SETTING IT IN POSITION AND PUSHING IT BACK UNTIL THE EMBOSSEMENTS SNAP INTO THE LOCKER LEG.

**LOCKER FOOT**

**DETAIL OF FOOT ASSEMBLY**

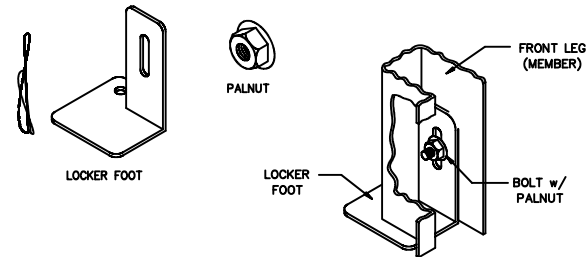

- 1.) ATTACH A LOCKER FOOT TO EACH FRONT LEG AS SHOWN. USE A #2 BOLT AND A PALNUT. IF END BASES ARE USED, THEY MUST BE ATTACHED BEFORE THE LOCKER FOOT.

**NOTE:** DRAW NUT UP TIGHT AFTER LOCKERS ARE SET IN PLACE AND LEVELED.

**RECOMMENDED ANCHORING METHODS**

(HARDWARE NOT FURNISHED BY LYON)

**ANCHORS FOR MASONRY:**

	MIN. PULL OUT VALUE IN LBS.
-3/16" SPRING WING TOGGLE BOLT	200
-9/64" DIA. HAMMER-IN DRIVE PINS	
3/4" PENETRATION	400
-3/16" x 7/8" NAIL DRIVE ANCHORS	500
-1/4" SPRING WING TOGGLE BOLT	650
-RAWPLUGS & #8 SH. METAL SCREWS	
1" PENETRATION	1190
-EXPANSION SCREWS FOR #10-24 SCREWS	
MIN. LENGTH 5/8"	1340
-1/4" x 1 1/8" ONE PIECE ANCHOR BOLT	1850
-1/4" x 1 3/4" STUD ANCHORS	1700

**ANCHORS FOR WOOD:**

	MIN. PULL OUT VALUE IN LBS.
-216" (#12) WOOD SCREWS	120
1" PENETRATION	180
1 1/2" PENETRATION	
-242" (#14) WOOD SCREWS	
1 PENETRATION	135
1 1/2" PENETRATION	202
-1/4" DIA. LAG BOLT	
1 PENETRATION	185
1 1/2" PENETRATION	277
-5/16" DIA. LAG BOLT	
1 PENETRATION	220
1 1/2" PENETRATION	330

**POWER ACTUATED ANCHORS:**

-9/64" DRIVE PIN	
3/4" PENETRATION	315
-5/32" DRIVE PIN	
1" PENETRATION	415